



Inductive sensor

NCN3-F31K2-N4-B33-S

- Direct mounting on standard actuators
- ATEX & IECEx certifications
- Usable up to SIL 2 acc. to IEC 61508
- Weatherproof housing for outdoor applications
- LEDs for switching state of sensor and solenoid valve
- Plug-in terminals
- Temperature range
-40 ... 100 °C (-40 ... 212 °F)
- 2 solenoid valves can be connected



Dimensions

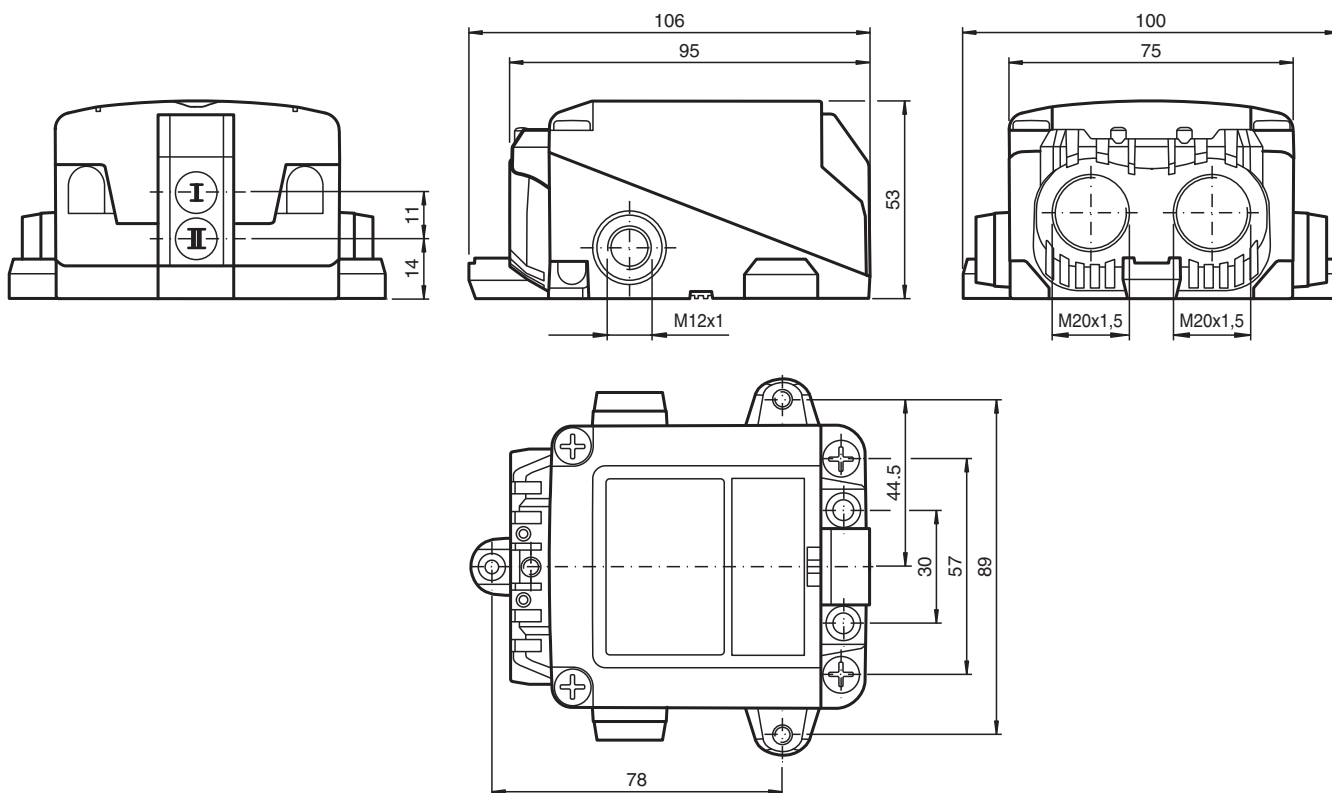

Technical Data

General specifications

Switching function	2 x normally closed (NC)
Output type	NAMUR

Release date: 2023-01-25 Date of issue: 2023-01-25 Filename: 235079_eng.pdf

Refer to "General Notes Relating to Pepperl+Fuchs Product Information".

Pepperl+Fuchs Group
www.pepperl-fuchs.com

USA: +1 330 486 0001
fa-info@us.pepperl-fuchs.com

Germany: +49 621 776 1111
fa-info@de.pepperl-fuchs.com

Singapore: +65 6779 9091
fa-info@sg.pepperl-fuchs.com

PF PEPPERL+FUCHS

Technical Data

Rated operating distance	s_n	3 mm
Installation		flush mountable
Assured operating distance	s_a	0 ... 2.4 mm For assured operating distance s_{ar} see Manual Functional Safety.
Actual operating distance	s_r	2.7 ... 3.3 mm typ.
Actuating element		Stainless steel 1.4305 / AISI 303 8.5 mm x 8.5 mm x 0.5 mm
Reduction factor r_{Al}		0.4
Reduction factor r_{Cu}		0.4
Reduction factor r_{304}		0.7
Reduction factor r_{St37}		1
Reduction factor r_{Brass}		0.5
Output type		2-wire
Nominal ratings		
Nominal voltage	U_o	8.2 V (R_i approx. 1 k Ω)
Switching frequency	f	0 ... 3 kHz
Hysteresis	H	typ. 5 %
Reverse polarity protection		reverse polarity protected
Short-circuit protection		yes
Suitable for 2:1 technology		yes , Reverse polarity protection diode not required
Current consumption		
Measuring plate not detected		≥ 3 mA
Measuring plate detected		≤ 1 mA
Time delay before availability	t_v	≤ 1.1 ms
Switching state indicator		LED, yellow
Valve status indicator		LED, yellow
Functional safety related parameters		
Safety Integrity Level (SIL)		SIL 2
MTTF _d		1730 a
Mission Time (T_M)		20 a
Diagnostic Coverage (DC)		0 %
Valve circuit		
Voltage		max. 32 V DC
Current		max. 240 mA
Short-circuit protection		no
Reverse polarity protection		yes, with reversed output LED is out of function, therefore more power for solenoid valve
Compliance with standards and directives		
Standard conformity		
NAMUR		EN 60947-5-6:2000 IEC 60947-5-6:1999
Electromagnetic compatibility		NE 21:2007
Standards		EN 60947-5-2:2007 EN 60947-5-2/A1:2012 IEC 60947-5-2:2007 IEC 60947-5-2 AMD 1:2012
Approvals and certificates		
IECEX approval		
Equipment protection level Ga		IECEX TUR 17.0055X
Equipment protection level Gb		IECEX TUR 17.0055X
Equipment protection level Mb		IECEX TUR 17.0055X
ATEX approval		
Equipment protection level Ga		TÜV 17 ATEX 8125 X
Equipment protection level Gb		TÜV 17 ATEX 8125 X
Equipment protection level Gc (ic)		PF13CERT2895 X
UL approval		cULus Listed, General Purpose, Class 2 Power Source

Release date: 2023-01-25 Date of issue: 2023-01-25 Filename: 235079_eng.pdf

Refer to "General Notes Relating to Pepperl+Fuchs Product Information".

Pepperl+Fuchs Group
www.pepperl-fuchs.comUSA: +1 330 486 0001
fa-info@us.pepperl-fuchs.comGermany: +49 621 776 1111
fa-info@de.pepperl-fuchs.comSingapore: +65 6779 9091
fa-info@sg.pepperl-fuchs.com

PEPPERL+FUCHS

Technical Data

Ordinary Location	E87056
Hazardous Location	E501628
Control drawing	116-0455
CCC approval	
Hazardous Location	2020322315002305
NEPSI approval	
NEPSI certificate	GYJ18.1172X
Ambient conditions	
Ambient temperature	-40 ... 100 °C (-40 ... 212 °F)
Storage temperature	-40 ... 100 °C (-40 ... 212 °F)
Mechanical specifications	
Connection type	screw terminals
Connection (system side)	Screw terminals, tightening torque min. 0.5 Nm Stripped length 7 mm , M20 x 1.5 cable gland , usable thread length 13.5 mm , screw-in depth max. 13.5 mm
Core cross section (system side)	rigid: 0.14 ... 2.5 mm ² flexible: 0.14 ... 1.5 mm ² flexible with core-end sleeve: 0.25 ... 1.5 mm ²
Connection (valve side)	4-pin, M12 x 1 socket
Core cross section (valve side)	like core cross section (system side)
Housing material	rugged, translucent polycarbonate (PC) optimised for outdoor use
Housing base	PC
Degree of protection	IP66 / IP67 / IP69
Tightening torque, fastening screws	4 Nm ... 5 Nm
Tightening torque, housing screws	≤ 2 Nm
Tightening torque of cover screws	1.5 Nm
Tightening torque, cable gland	M20 x 1.5 ; max. 7 Nm
Tightening torque, stopping plug	1 Nm
Note	LED switch-off
General information	
Use in the hazardous area	see instruction manuals

Connection

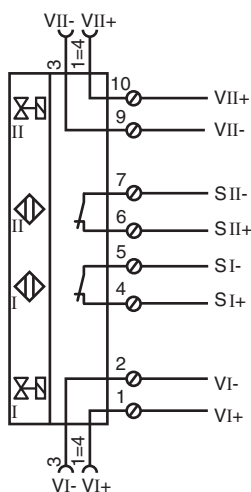









Release date: 2023-01-25 Date of issue: 2023-01-25 Filename: 235079_eng.pdf

Additional Information

Interruption of LED:

In the case of a polarity reversal of the valve circuit connection/s, the valve status display does not function, i.e. such that low power valves can (also) be connected.

Accessories

	BT65-F31K2-RG-EN	Activator for F31K2 series
	BT65A	Activator for F31 series
	BT65X	Activator for F31 series
	BT115A	Activator for F31 series
	BT115X	Activator for F31 series
	VMB-2+P/Z2-0,3M-PVC-V1-W-Y	Valve connector, Form B on M12, 2+PE, LED, Z diode, PVC cable
	VMBI-2+P/Z2-0,3M-PVC-V1-W-Y	Valve connector, Form B (Ind) on M12, 2+PE, LED, Z diode, PVC cable
	VMA-2+P/Z2-0,3M-PVC-V1-W-Y	Valve connector, Form A on M12, 2+PE, LED, Z diode, PVC cable